

LOCATION POWER SERVICE
 120V, 3A, 50/60Hz
 A DEDICATED SERVICE IS
 RECOMMENDED.

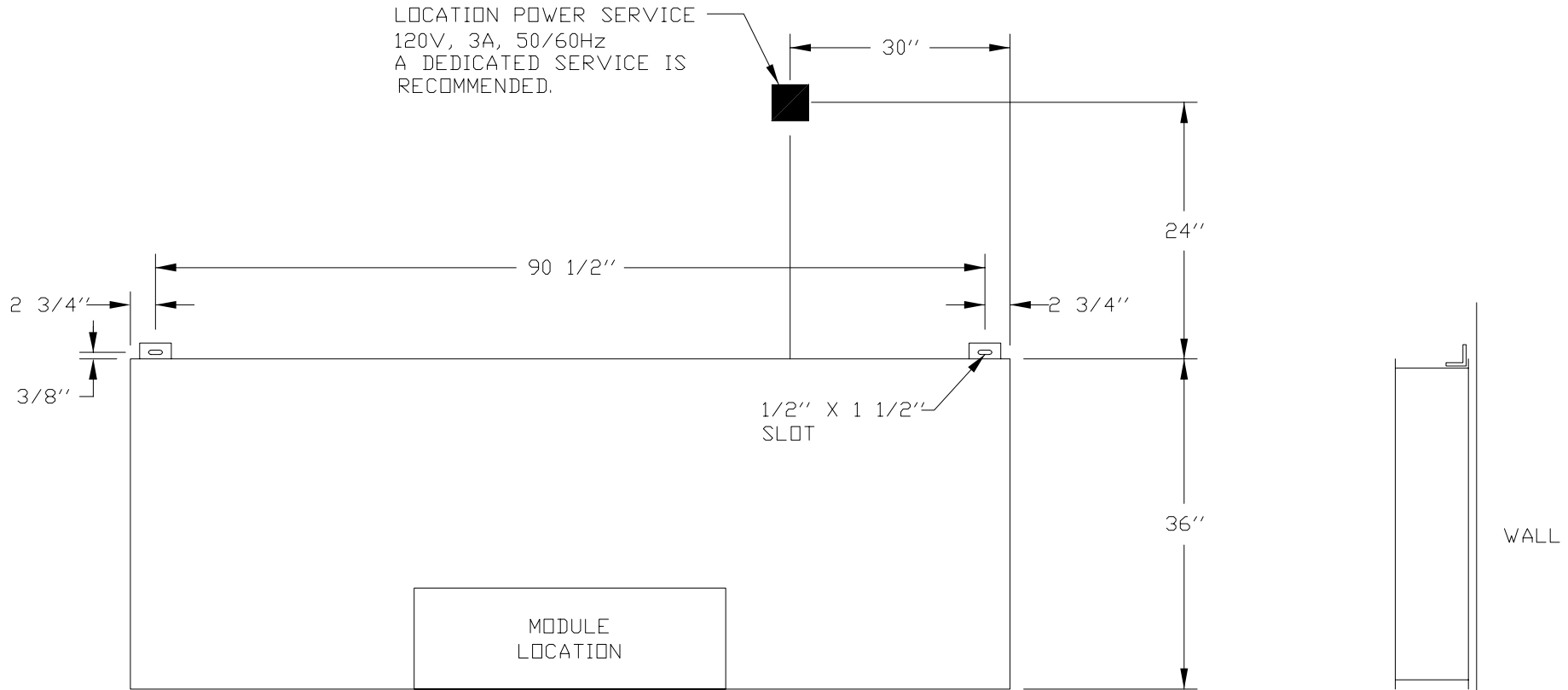

APPROXIMATE WEIGHT 71 LBS.

FRONT VIEW

THIS SCOREBOARD IS INTENDED TO BE INSTALLED IN ACCORDANCE WITH THE REQUIREMENTS OF ARTICLE 600 OF THE NATIONAL ELECTRICAL CODE AND/OR OTHER APPLICABLE LOCAL CODES. THIS INCLUDES PROPER GROUNDING AND BONDING OF THE SCOREBOARD.

1. IF THE SCOREBOARD IS TO BE USED FOR 2-WIRE OPERATION REFER TO POWER HOOK UP PRINT.
2. IF THE SCOREBOARD IS TO BE USED FOR WIRELESS OPERATION REFER TO RECEIVER INSTALLATION PRINT FOR SPECIFIC CONTROL.

INSTALLATION 2600		 NEVCO SCOREBOARD CO. GREENVILLE, ILLINOIS 62246
DRAWN HW		
DATE 10/18/04	SHEET 1 OF 1	

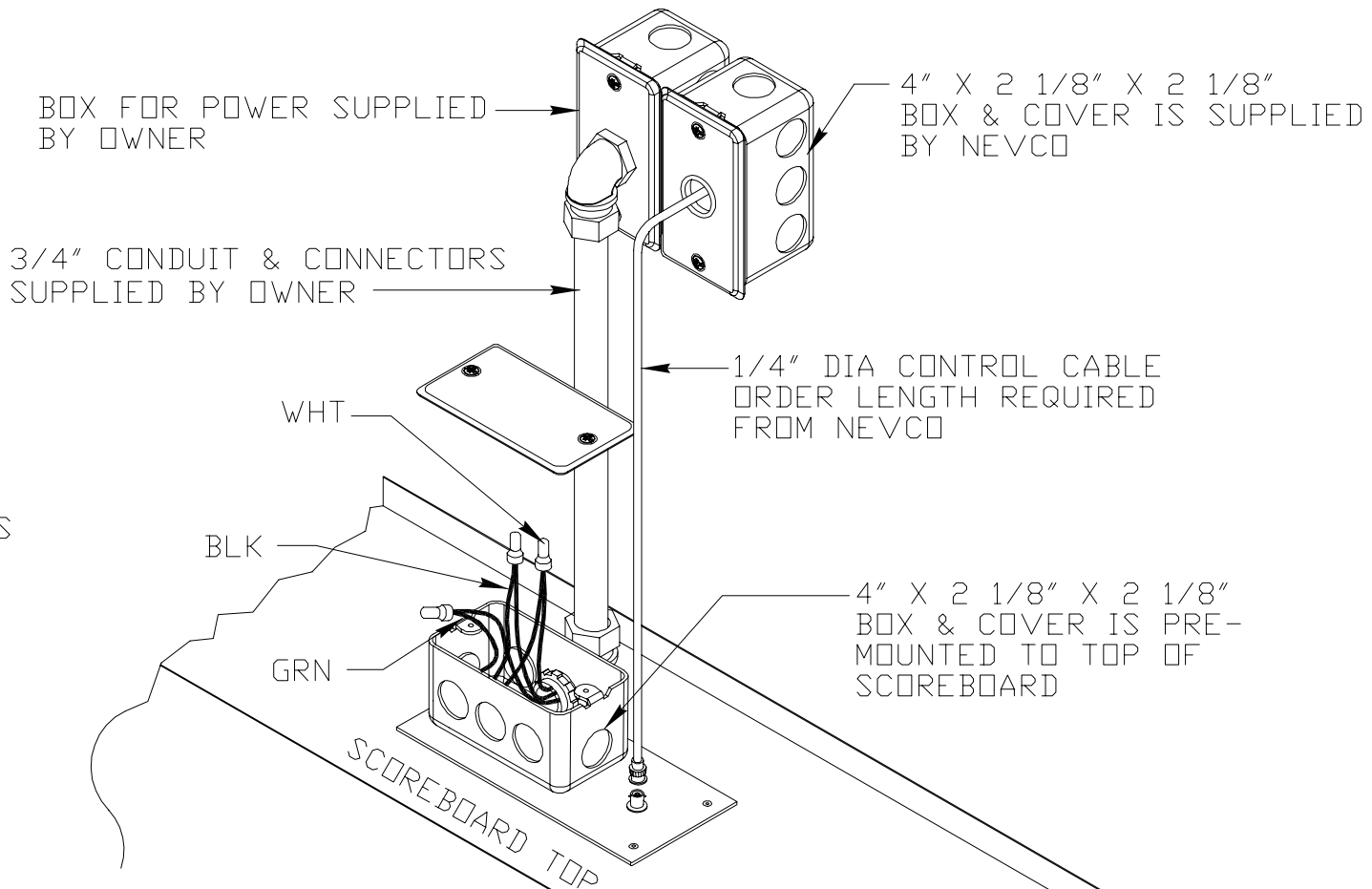

120V, 50/60Hz

- 1 BLK - HOT
- 1 WHT - NEUTRAL
- 1 GRN - GROUND

FOR POWER REQUIREMENTS
SEE INSTALLATION PRINT

NOTE:

THIS SCOREBOARD IS INTENDED TO BE INSTALLED IN ACCORDANCE WITH THE REQUIREMENTS OF ARTICLE 600 OF THE NATIONAL ELECTRICAL CODE AND/OR OTHER APPLICABLE LOCAL CODES. THIS INCLUDES PROPER GROUNDING AND BONDING OF THE SCOREBOARD.

POWER HOOK UP SINGLE MODULE SCOREBOARD FOR 2-WIRE OPERATION		 NEVCO SCOREBOARD CO. GREENVILLE, ILLINOIS 62246
DRAWING NO. C10054		
DRAWN HW	DATE 10/18/04	SHEET 1 OF 1

Scoreboard with MPCX Receiver

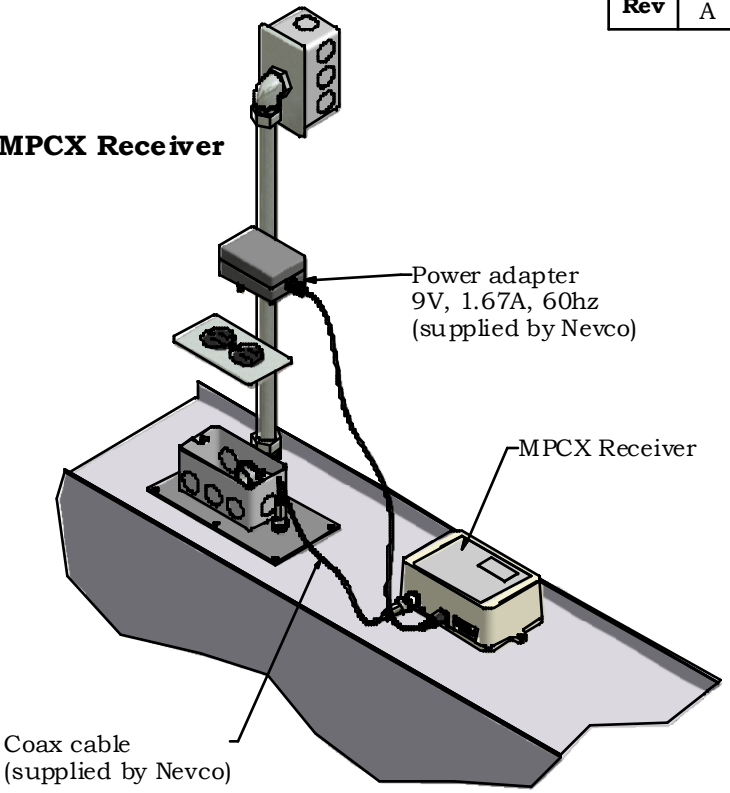

Scoreboard with MPCW/MPCHA Receiver

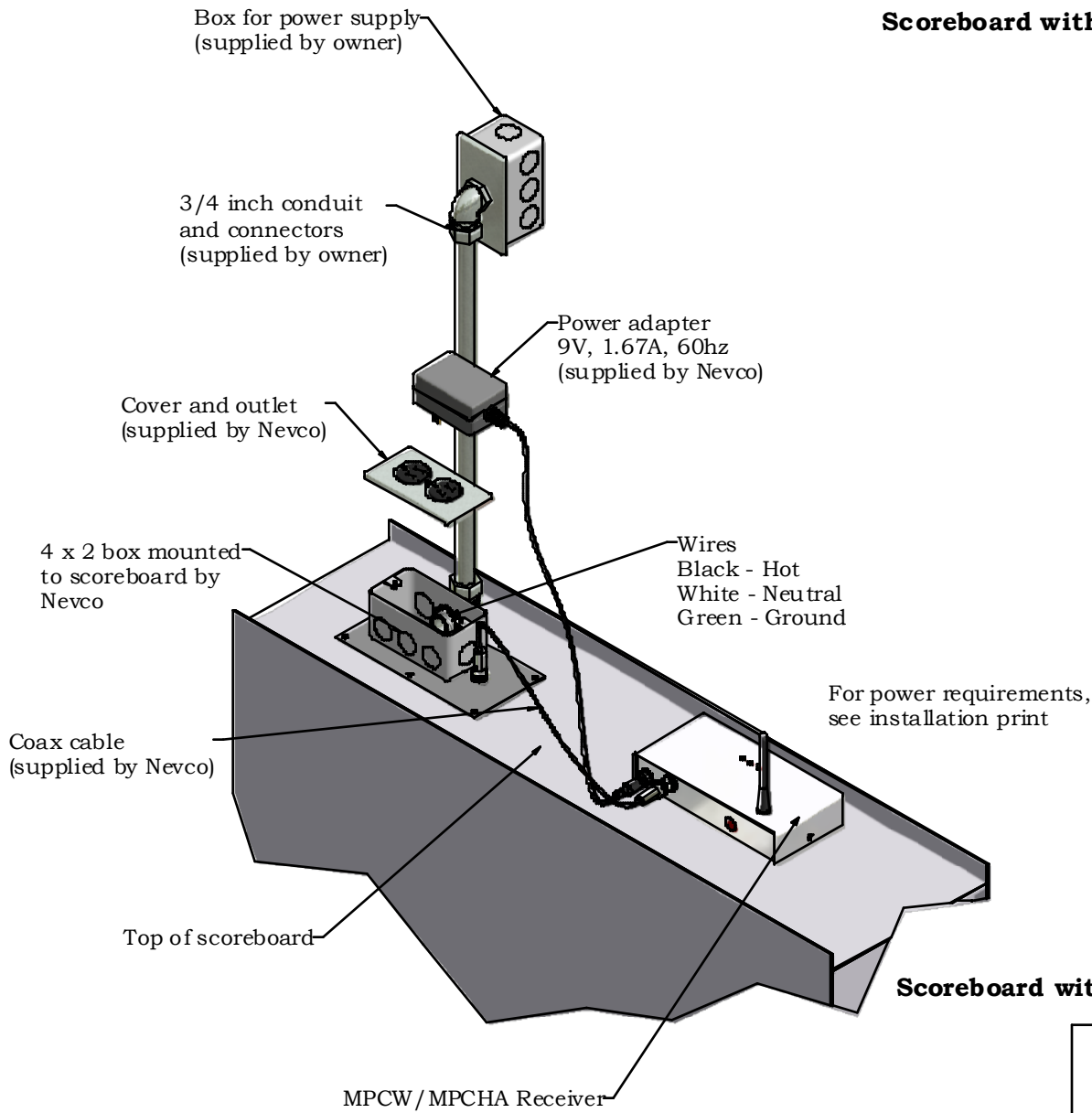

Note:
 This scoreboard is intended to be installed in accordance with the requirements of Article 600 of the National Electrical Code and/or other applicable local codes. This includes proper grounding and bonding of the scoreboard.

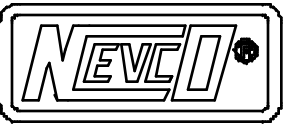
Installation of MPCW/MPCHA/MPCX Top Mount Receiver		 Nevco Scoreboard Company Greenville, Illinois 62246
Drawing No. 275-0134	Sheet 1 of 1	
Drawn BRS	Date 9/14/07	